



The information provided in this documentation contains general descriptions and/or technical characteristics of the performance of the products contained herein. This documentation is not intended as a substitute for and is not to be used for determining suitability or reliability of these products for specific user applications. It is the duty of any such user or integrator to perform the appropriate and complete risk analysis, evaluation and testing of the products with respect to the relevant specific application or use thereof. Neither Schneider Electric Industries SAS nor any of its affiliates or subsidiaries shall be responsible or liable for misuse of the information contained herein.



Main

Range of product	Altivar Soft Starter ATS480
Product or component type	Soft starter
Product destination	Asynchronous motors
Product specific application	Process and infrastructures
Device short name	ATS480
Network number of phases	3 phases
Utilisation category	AC-3A AC-53A
Ue power supply voltage	208...690 V - 15...10 %
Power supply frequency	50...60 Hz - 20...20 %
[Ie] rated operational current	Normal duty: 140.0 A (at <40 °C)
Rated current in heavy duty	110.0 A at 40 °C for heavy duty
Torque control	True
IP degree of protection	IP00
Motor power kW	37.0 KW at 230 V in the motor supply line normal duty 30.0 KW at 230 V in the motor supply line heavy duty 75.0 KW at 400 V in the motor supply line normal duty 55.0 KW at 400 V in the motor supply line heavy duty 75.0 KW at 440 V in the motor supply line normal duty 55.0 KW at 440 V in the motor supply line heavy duty 90.0 KW at 500 V in the motor supply line normal duty 75.0 KW at 500 V in the motor supply line heavy duty 90.0 KW at 525 V in the motor supply line normal duty 75.0 KW at 525 V in the motor supply line heavy duty 110.0 KW at 660 V in the motor supply line normal duty 90.0 KW at 660 V in the motor supply line heavy duty 110.0 KW at 690 V in the motor supply line normal duty 90.0 KW at 690 V in the motor supply line heavy duty 75.0 KW at 230 V to the motor delta terminals normal duty 55.0 KW at 230 V to the motor delta terminals heavy duty 110.0 KW at 400 V to the motor delta terminals normal duty 90.0 kW at 400 V to the motor delta terminals heavy duty

Motor power hp	40.0 Hp at 208 V normal duty 30.0 Hp at 208 V heavy duty 50.0 Hp at 230 V normal duty 40.0 Hp at 230 V heavy duty 100.0 Hp at 460 V normal duty 75.0 Hp at 460 V heavy duty 125.0 Hp at 575 V normal duty 100.0 hp at 575 V heavy duty
Option card	Communication module for Profibus DP V1 Communication module for PROFINET Communication module for Modbus TCP/EtherNet/IP Communication module for CANopen daisy chain Communication module for CANopen Sub-D Communication module for CANopen open style

Complementary

Device connection	In the motor supply line To the motor delta terminals
[Us] control circuit voltage	110...230 V AC 50/60 Hz - 15...10 %
Apparent power	0.09 kVA
Integrated motor overload protection	True
Motor thermal protection class	Class 10E
Protection type	Phase failure: line Integrated thermal protection: motor Thermal protection: starter Current overload: motor Underload: motor Excessive starting time, locked rotor: motor Motor phase loss: motor Line supply phase loss: line Line supply phase loss: motor Thermal protection: motor
Current limiting %In (5 x Ie maximum)	150...700 %
Rated current pwr loss specification	140.0 A
Power loss static current independent	25.0 W
Power loss per device current dependent	366.0 W
Standards	EN/IEC 60947-4-2 UL 60947-4-2 IEC 60664-1
Product certifications	CE CULus CCC UKCA RCM EAC DNV ABS BV CCS
Marking	CE CCC UKCA EAC RCM CULus
[Uc] control circuit voltage	24 V DC
Discrete input number	4
Discrete input type	(STOP) logic inputs, 3500 Ohm (RUN) logic inputs, 3500 Ohm (DI3) programmable as logic input, 3500 Ohm (DI4) programmable as logic input, 3500 Ohm
Input compatibility	STOP: discrete input level 1 PLC conforming to EN/IEC 61131-2 RUN: discrete input level 1 PLC conforming to EN/IEC 61131-2 DI3: discrete input level 1 PLC conforming to EN/IEC 61131-2 DI4: discrete input level 1 PLC conforming to EN/IEC 61131-2
Discrete input logic	Programmable digital input at State 0: < 5 V
Relay output number	3

Relay output type	Relay outputs R1A 1 NO Relay outputs R1B 1 NO Relay outputs RIC NO/NC programmable
Minimum switching current	10 mA at 24 V DC for relay outputs
Maximum switching current	Relay outputs 2 A at 250 V AC Relay outputs 2 A at 30 V DC Relay outputs
Discrete output number	2
Discrete output type	(DQ1) programmable digital output <= 30 V (DQ2) programmable digital output <= 30 V
Output compatibility	Open collector level 1 PLC conforming to IEC 65A-68
Analogue input number	1
Analogue input type	AI1/PTC PTC/Pt 100 temperature probe PTC2 PTC/Pt 100 temperature probe PTC3 PTC/Pt 100 temperature probe
Analogue output number	1
Analogue output type	Current output AQ1: 0...20 mA or 0...10 V, impedance <500 Ohm
Communication port protocol	Modbus serial
Connector type	1 RJ45
Communication data link	Serial
Physical interface	2-wire RS 485
Transmission rate	1200...256000 bit/s
Transmission frame	RTU
Data format	8 bits, configurable odd, even or no parity
Type of polarization	No impedance for Modbus serial
Number of addresses	0...227 for Modbus serial
Method of access	Slave Modbus serial
Function available	External bypass control Pre-heating Smoke extraction Multi-motor cascade Second motor set User management Ports and services hardening Security event logging Cybersecure firmware update Single direction
Display screen available	True
Operating position	Vertical +/- 10 degree
Height	340.0 mm
Width	200.0 mm
Depth	272.0 mm
Net weight	12.4 kg

Environment

Electromagnetic compatibility	Conducted and radiated emissions level A conforming to IEC 60947-4-2 Conducted and radiated emissions with bypass level B conforming to IEC 60947-4-2 Damped oscillating waves level 3 conforming to IEC 61000-4-12 Electrostatic discharge level 3 conforming to IEC 61000-4-11 Immunity to electrical transients level 4 conforming to IEC 61000-4-4 Immunity to radiated radio-electrical interference level 3 conforming to IEC 61000-4-3 Voltage/current impulse level 3 conforming to IEC 61000-4-5
Pollution degree	Level 3
[Uimp] rated impulse withstand voltage	6 kV
[Ui] rated insulation voltage	690 V
Environmental class (during operation)	Class 3C3 according to IEC 60721-3-3 Class 3S2 according to IEC 60721-3-3
Relative humidity	0...95 % without condensation or dripping water conforming to EN/IEC 60068-2-3
Ambient air temperature for operation	40...60 °C (with current derating of 2 % per °C) -15...40 °C (without derating)
Ambient air temperature for storage	-25...70 °C

Operating altitude	<= 1000 m without derating > 1000...4000 m with current derating 1 % per 100 m
Maximum deflection under vibratory load (during operation)	1.5 mm at 2...13 Hz
Maximum deflection under vibratory load (during storage)	1.75 mm at 2...9 Hz
Maximum deflection under vibratory load (during transport)	1.75 mm at 2...9 Hz
Maximum acceleration under vibrational stress (during operation)	10 m/s ² at 13...200 Hz
Maximum acceleration under vibratory load (during storage)	15 m/s ² at 200...500 Hz 10 m/s ² at 9...200 Hz
Maximum acceleration under vibratory load (during transport)	15 m/s ² at 200...500 Hz 10 m/s ² at 9...200 Hz
Maximum acceleration under shock impact (during operation)	150 m/s ² at 11 ms
Maximum acceleration under shock load (during storage)	100 m/s ² at 11 ms
Maximum acceleration under shock load (during transport)	100 m/s ² at 11 ms

Packing Units

Unit Type of Package 1	PCE
Number of Units in Package 1	1
Package 1 Height	43.0 cm
Package 1 Width	32.0 cm
Package 1 Length	45.5 cm
Package 1 Weight	14.386 kg
Unit Type of Package 2	S06
Number of Units in Package 2	2
Package 2 Height	75.0 cm
Package 2 Width	60.0 cm
Package 2 Length	80.0 cm
Package 2 Weight	41.775 kg

Offer Sustainability

Sustainable offer status	Green Premium product
REACH Regulation	REACH Declaration
EU RoHS Directive	Pro-active compliance (Product out of EU RoHS legal scope) EU RoHS Declaration
Mercury free	Yes
RoHS exemption information	Yes
China RoHS Regulation	China RoHS Declaration
Environmental Disclosure	Product Environmental Profile
Circularity Profile	End Of Life Information
WEEE	The product must be disposed on European Union markets following specific waste collection and never end up in rubbish bins
Upgradeability	Upgraded components available

Contractual warranty

Warranty	18 months
----------	-----------

Dimensions

Front, Side and Rear View

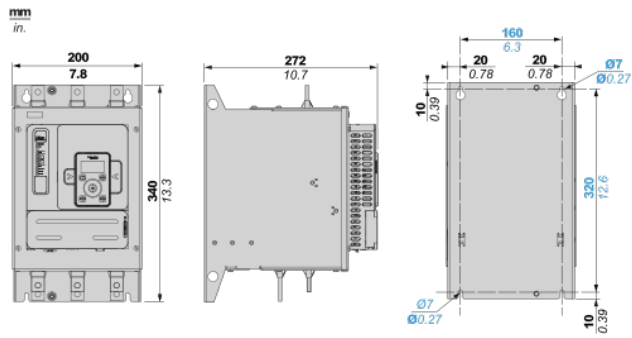

Power Connections

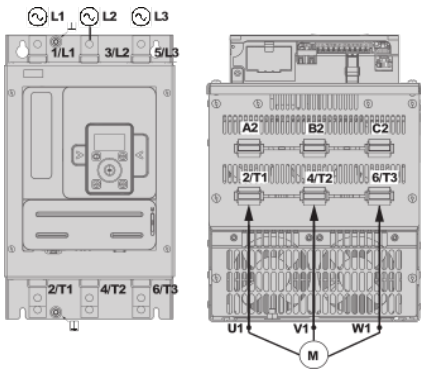

- (1) : Mains side
- (2) : Motor side
- 1/L1, 3/L2, 5/L3 : Mains supply inputs
- 2/T1, 4/T2, 6/T3 : Outputs to motor
- A2, B2, C2 : Soft starter bypass

Connection in line, with line contactor, no bypass, type 1 or 2 coordination, non - reversing, 2-wire or 3-wire control

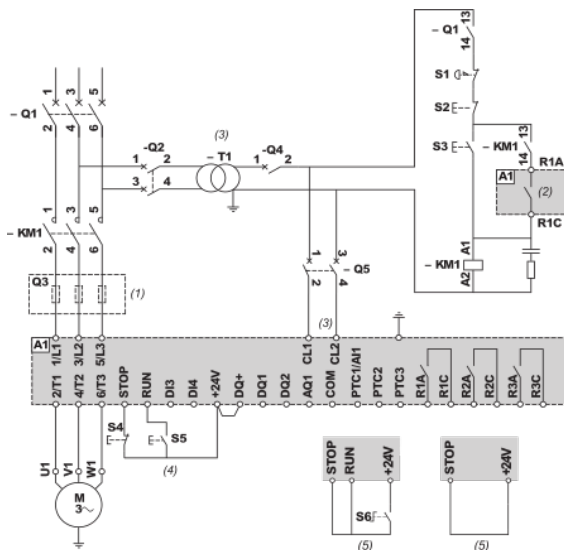

- (1) : Installation of additional fast-acting fuses to upgrade to type 2 coordination according to IEC 60947-4-2.
- (2) : Take into account the electrical characteristics of the relays (Control Terminal Characteristics).
- (3) : The transformer must supply 110...230 VAC +10% — 15%, 50/60Hz.
- (4) : RUN and STOP Management (3-wire control).
- (5) : RUN and STOP Management (2-wire control).

Connection in line, with line and bypass contactor, freewheel or controlled stop, type 1 or 2 coordination, non reversing, 2-wire or 3-wire

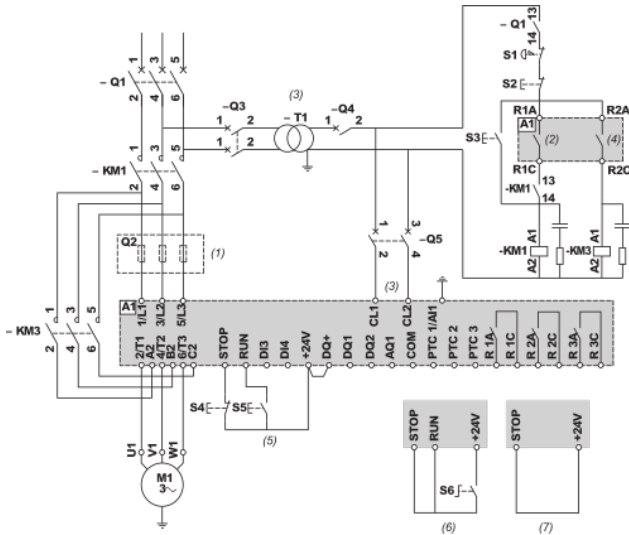

- (1) : Installation of additional fast-acting fuses to upgrade to type 2 coordination according to IEC 60947-4-2.
- (2) : Take into account the electrical characteristics of the relays (Control Terminal Characteristics).
- (3) : The transformer must supply 110...230 VAC +10% – 15%, 50/60Hz.
- (4) : Take into account the electrical characteristics of the relays, especially when connecting to high rating contactor (Control Terminal Characteristics).
- (5) : RUN and STOP Management (3-wire control).
- (6) : RUN and STOP Management (2-wire control).
- (7) : PC or PLC control

Connection inside the delta, with line and bypass contactor, type 1 and 2 coordination, non reversing, 2 wire or 3 wire

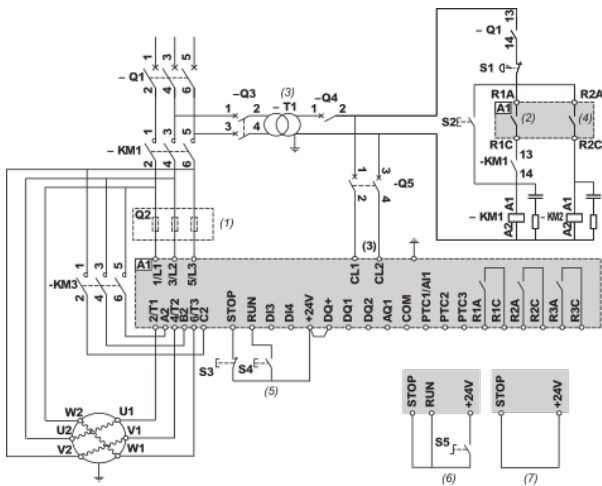

- (1) : Installation of additional fast-acting fuses to upgrade to type 2 coordination according to IEC 60947-4-2.
- (2) : Take into account the electrical characteristics of the relays (Control Terminal Characteristics).
- (3) : The transformer must supply 110...230 VAC +10% – 15%, 50/60Hz.
- (4) : Take into account the electrical characteristics of the relays, especially when connecting to high rating contactor (Control Terminal Characteristics).
- (5) : RUN and STOP Management (3-wire control).
- (6) : RUN and STOP Management (2-wire control).
- (7) : PC or PLC control

Control block wiring diagram

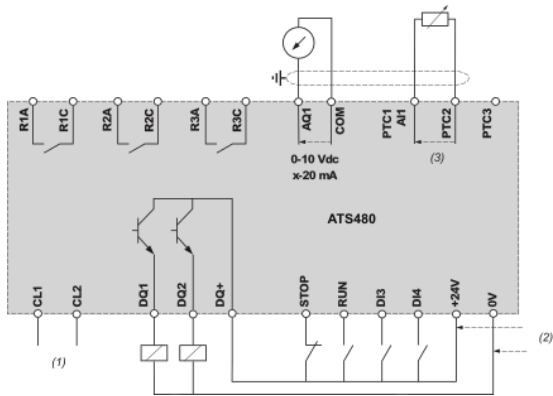

(1) : Control power supply 110-230 VAC

(2) : External supply 24 VDC

(3) : 2 Wires PTC/PT100

R1A, R1C, R3A, R3C : Sequence relay

R2A, R2C : End of start

STOP, RUN, DI3, DI4 : Digital inputs

AQ1 : Analogue output

PTC1/AI1, PTC2, PTC3 : PTC or PT100 connection

DQ1, DQ2, DQ+ : Digital outputs

Mounting Position

